



## Fumisteria

[Per maggiori dettagli »](#)

PER L'INTERA GAMMA DEI PRODOTTI DA NOI TRATTATI PREGHIAMO CONSULTARE NOSTRO CATALOGO COMPLETO  
PER NOVITÀ O MERCE OBSOLETA PREGHIAMO VISIONARE O SCARICARE DOCUMENTI NELLA SEZIONE DOWNLOAD











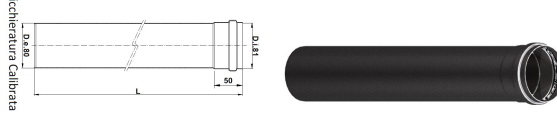
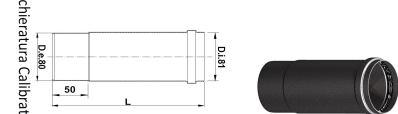

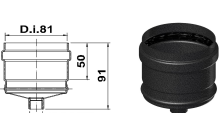
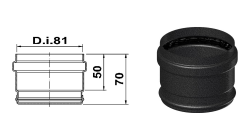

**G.T. TADDIA S.R.L.**

VIA MASCARINO N. 22 – 40066 PIEVE DI CENTO (BO)  
TEL 051 975215 - [www.gttaddiasrl.it](http://www.gttaddiasrl.it) - [info@gttaddiasrl.it](mailto:info@gttaddiasrl.it)

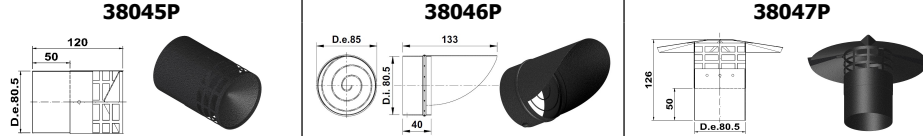
# ACCESSORI SCARICO FUMI/ASPIRAZIONE ARIA

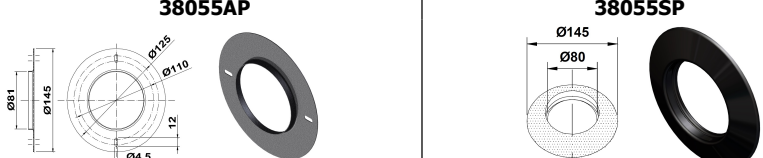
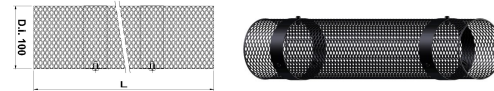
## SISTEMA SDOPPIATO Ø 80 LINEA PELLETTA

<p><b>TUBO M/F 12/10</b> in acciaio nero opaco- bicchieratura calibrata completo di guarnizione a triplo labbro in silicone nero</p>  <p>Bicchieratura Calibrata</p> <table border="1"> <thead> <tr> <th></th> <th>mm.</th> <th>Pz/conf.</th> </tr> </thead> <tbody> <tr> <td><b>38022025P</b></td> <td>250</td> <td>1</td> </tr> <tr> <td><b>38022050P</b></td> <td>500</td> <td>1</td> </tr> <tr> <td><b>38022100P</b></td> <td>1000</td> <td>1</td> </tr> <tr> <td><b>38022150P</b></td> <td>1500</td> <td>1</td> </tr> <tr> <td><b>38022200P</b></td> <td>2000</td> <td>1</td> </tr> </tbody> </table>		mm.	Pz/conf.	<b>38022025P</b>	250	1	<b>38022050P</b>	500	1	<b>38022100P</b>	1000	1	<b>38022150P</b>	1500	1	<b>38022200P</b>	2000	1	<p><b>TUBO</b> telescopico M/F 12/10 in acciaio nero opaco completo di guarnizione a triplo labbro in silicone nero</p>  <p>Bicchieratura Calibrata</p> <table border="1"> <thead> <tr> <th></th> <th>mm.</th> <th>Pz/conf.</th> </tr> </thead> <tbody> <tr> <td><b>38025021P</b></td> <td>210</td> <td>2</td> </tr> </tbody> </table>		mm.	Pz/conf.	<b>38025021P</b>	210	2
	mm.	Pz/conf.																							
<b>38022025P</b>	250	1																							
<b>38022050P</b>	500	1																							
<b>38022100P</b>	1000	1																							
<b>38022150P</b>	1500	1																							
<b>38022200P</b>	2000	1																							
	mm.	Pz/conf.																							
<b>38025021P</b>	210	2																							
<p><b>CURVA</b> in acciaio M/F 12/10 nero opaco - Pz/conf. 4 completo di guarnizione a triplo labbro in silicone nero</p>																									
<p><b>90° con ispezione</b> <b>38028P</b></p> 	<p><b>90°</b> <b>38029P</b></p> 	<p><b>45°</b> <b>38030P</b></p> 																							
<p><b>TEE</b> in acciaio 12/10 nero opaco - Pz/conf 2 completo di guarnizione a triplo labbro in silicone nero <b>Maschio/Femmina/Femmina</b> <b>38035P</b> Lunghezza 206 mm.</p> 	<p><b>TAPPO</b> in acciaio 12/10 nero opaco Pz/conf. 2</p> <p><b>SCARICO CONDENSA</b> <b>38037P</b></p> 	<p><b>ISPEZIONE</b> <b>38038P</b></p> 																							
<p><b>TUBO</b> in acciaio 12/10 nero opaco - Pz/conf. 2 Lunghezza 150 mm. completo di guarnizione a triplo labbro in silicone nero</p> <p><b>Femmina/Femmina</b> <b>38041FFP</b></p> 	<p><b>Maschio/Femmina</b> <b>38042MFP</b></p> 	<p><b>TERMINALE A BOTTE ANTIVENTO</b> con attacco M in acciaio inox AISI 304 <b>38043P</b></p> 																							
<p><b>TERMINALI SCARICO FUMI</b> in acciaio inox AISI 304 nero opaco</p> <table border="1"> <thead> <tr> <th>Pz/conf.</th> <th>ORIZZONTALE</th> <th>ORIZZONTALE con cappello parapiovvia Ø 80</th> <th>VERTICALE</th> </tr> </thead> <tbody> <tr> <td>4</td> <td><b>38045P</b></td> <td><b>38046P</b></td> <td><b>38047P</b></td> </tr> </tbody> </table> 		Pz/conf.	ORIZZONTALE	ORIZZONTALE con cappello parapiovvia Ø 80	VERTICALE	4	<b>38045P</b>	<b>38046P</b>	<b>38047P</b>	<p><b>KIT PER ASPIRAZIONE ARIA</b> Tubo Ø60 flessibile estendibile L300/920 mm. in alluminio, terminale aria in acciaio inox e riduzione Pz/conf. 2</p>  <p><b>38040P40</b> riduzione Ø 40 <b>38040P50</b> riduzione Ø 50</p>															
Pz/conf.	ORIZZONTALE	ORIZZONTALE con cappello parapiovvia Ø 80	VERTICALE																						
4	<b>38045P</b>	<b>38046P</b>	<b>38047P</b>																						
<p><b>COLLARE</b> in acciaio nero opaco Pz/conf. 10 Lunghezza gambo 200 mm. <b>38050P</b></p> 	<p><b>ROSONE COPRIMURO</b></p> <table border="1"> <thead> <tr> <th>in acciaio 8/10 nero opaco - Pz/conf. 6</th> <th>in silicone nero - Pz/conf. 10</th> </tr> </thead> <tbody> <tr> <td><b>38055AP</b></td> <td><b>38055SP</b></td> </tr> </tbody> </table> 		in acciaio 8/10 nero opaco - Pz/conf. 6	in silicone nero - Pz/conf. 10	<b>38055AP</b>	<b>38055SP</b>																			
in acciaio 8/10 nero opaco - Pz/conf. 6	in silicone nero - Pz/conf. 10																								
<b>38055AP</b>	<b>38055SP</b>																								
<p><b>RETE</b> in acciaio DI PROTEZIONE Ø 100 nero opaco</p>  <table border="1"> <thead> <tr> <th></th> <th>mm.</th> <th>Pz/conf.</th> </tr> </thead> <tbody> <tr> <td><b>38060050P</b></td> <td>500</td> <td>1</td> </tr> <tr> <td><b>38060100P</b></td> <td>1000</td> <td>1</td> </tr> </tbody> </table>		mm.	Pz/conf.	<b>38060050P</b>	500	1	<b>38060100P</b>	1000	1	<p><b>GUARNIZIONE</b> in silicone nero a triplo labbro</p>  <p><b>38065P</b> Pz/conf. 10</p>															
	mm.	Pz/conf.																							
<b>38060050P</b>	500	1																							
<b>38060100P</b>	1000	1																							

FUMISTERIA



G.T. TADDIA s.r.l.

# ACCESSORI SCARICO FUMI/ASPIRAZIONE ARIA

## SISTEMA SDOPPIATO Ø 60 - Ø 80 - Ø 100

**TUBO** IN ALLUMINIO ESTRUSO – Maschio/ Femmina – sp. 1,00 mm.  
completo di guarnizione a labbro in silicone



Ø 60			Ø 80		
Verniciato bianco	mm.	pz/conf.	Verniciato bianco	mm.	pz/conf.
<b>38100</b>	500	10	<b>38115</b>	250	12
			<b>38117</b>	500	9
			<b>38119</b>	1000	10

*Sui tubi ns art. 38119 per richieste di quantitativi inferiori alle confezioni aumento 10%*

**CURVA 90°** IN ALLUMINIO PRESSOFUSO completa di guarnizione a labbro in silicone

RAGGIO STRETTO Ø 60  
**38141**



Femmina/Femmina

RAGGIO LARGO Ø 60 sp. 2,00 mm.  
**38148**



Femmina/Femmina

RAGGIO STRETTO Ø 80 sp. 2,00 mm.  
**38160**



Maschio/Femmina

**38163**



Femmina/Femmina

RAGGIO LARGO Ø 80 sp. 2,00 mm.  
**38168**



Maschio/Femmina  
ispezione fumi



Femmina/Femmina

**CURVA 45°** completa di guarnizione a labbro in silicone – verniciata bianca  
IN ALLUMINIO PRESSOFUSO

Ø 80 sp. 2,00 mm.  
**38200**



Femmina/Femmina

**MANICOTTO** IN ALLUMINIO ESTRUSO completo di guarnizione a labbro in silicone – verniciato bianco

Ø 80  
sp. 1,00 mm  
**38226**



M/F L = 150 mm. Ispezione fumi

**TEE Ø 80** IN ALLUMINIO PRESSOFUSO completo di guarnizione a labbro in silicone – verniciato bianco  
sp. 2,00 mm. (lega EN AB-46100)

**38247**



tappo scarico condensa

**38248**



con flangia ø 128 per Savio

### TERMINALI SCARICO FUMI

ORIZZONTALE - ACCIAIO  
INOX



**38255** Ø 60  
**38258** Ø 80  
**38262** Ø 100

VERTICALE - ACCIAIO  
INOX/ACCIAIO



**38273** Ø 80  
**38276** Ø 100

### TERMINALI ASPIRAZIONE ARIA

ACCIAIO INOX



**38285** Ø 60  
**38290** Ø 80



**38292** Ø 80  
con cappello parapiovvia

POLIPROPILENE



**38293** Ø 80



FUMISTERIA







G.T. TADDIA s.r.l.

# ACCESSORI SCARICO FUMI/ASPIRAZIONE ARIA

## SISTEMA SDOPPIATO Ø 60 - Ø 80 - Ø 100

<b>ROSONE COPRIMURO</b>		<b>COLLARE</b>
IN <b>LAMIERA</b> – <i>VERNICIATA BIANCA</i>	IN <b>EPDM</b> <i>BIANCO</i>	IN <b>ACCIAIO</b> - <i>VERNICIATO BIANCO</i> Lunghezza gambo 200 mm.
		
<b>38301</b> Ø 60 <b>38304</b> Ø 80	<b>38310</b> Ø 60 <b>38313</b> Ø 80	<b>38318</b> Ø 80 <b>38321</b> Ø 100

<b>GUARNIZIONI IN SILICONE A LABBRO</b>		<b>O-RING</b>	<b>MANICOTTO</b>
<i>SILICONE ROSSO</i>	<i>SILICONE AZZURRO</i>	<i>SILICONE ROSSO</i>	IN SILICONE CON FASCETTA METALLICA <i>VERNICIATO BIANCO</i>
			
<b>38319</b> Ø 60 (solo per curve 90° raggio stretto)	<b>38320</b> Ø 60 <b>38323</b> Ø 80 <b>38326</b> Ø 100	<b>38330</b> Ø 60	<b>38335</b> Ø 80

**RIDUZIONE IN ALLUMINIO DA TUBO ESTRUSO**  
*completa di guarnizione in silicone*

<b>Ø 80-60</b> sp. 1,50 mm. <b>38346</b>	<b>Ø 100-80</b> sp. 1,20 mm. <b>38350</b>	<b>38353</b>
		
Femmina/Maschio	Maschio/Femmina	Femmina/Maschio

**SDOPPIATORE MONOBLOCCO USCITE Ø 80/80** PER CALDAIE DA INTERNO verniciato bianco  
*completo di guarnizioni, aerstop, o-rings e viti*

**38386**



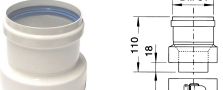

Femmina/Femmina  
con attacco flangia Ø 128  
Compatibile per: Biasi - Savio

<b>RACCORDO DI PARTENZA PER SCARICO FUMI/ASPIRAZIONE ARIA</b> verniciato bianco <i>completo di guarnizioni, aerstop e viti</i>	<b>completo di guarnizione</b>
<b>38417</b>	<b>38432</b>
	
<i>con ispezione fumi</i>	
Compatibile per: Arca (Step) – Baltur – Biasi - Bongioanni – Euroterm – Finterm - Fondital – Fontecal – Hermann- Lamborghini- Pensotti- Rhoss – Roca - Sant'Andrea – Sarigas - Sile- Sime	Compatibile per: Chaffoteaux et Maury – El.Co – Ariston - Simat

**RACCORDO DI PARTENZA**  
PER SCARICO FUMI *CALDAIE ESTERNO*  
verniciato bianco  
*completo di guarnizione, aerstop e viti*

**38452**



con flangia Ø 128

Compatibile per: Arca(Step) – Baltur – Biasi - Bongioanni – Finterm – Fondital – Hermann – Lamborghini – Pensotti – Radiant  
(52530LP) - Rhoss – Roca – Riello - Sant'Andrea - Sarigas – Sile – Sime – Sylber - Unical

FUMISTERIA



G.T. TADDIA s.r.l.

# ACCESSORI SCARICO FUMI/ASPIRAZIONE ARIA

## SISTEMA COASSIALE Ø 60/100

### CURVA DI PARTENZA

**38630CP**  
IN ACCIAIO STAMPATO



### PARTENZA VERTICALE

IN ALLUMINIO CON ATTACCO A FASCETTA Ø 60/100  
completa di guarnizioni - verniciata bianca -

Femmina/Femmina  
**38750**



c/att.Ø 60 Femmina  
Compatibile per: Beretta – Riello – Sylber

### CONDOTTO COASSIALE IN ALLUMINIO Ø 60/100 verniciato bianco completo di terminale e molle di centraggio

#### Terminale Pbt



**38824** 1000 mm.

#### Terminale inox



**38834** 1000 mm.

### CURVA Ø 60/100 PER SISTEMA COASSIALE verniciata bianca

90°

#### Fascetta

In alluminio stampato

**38860**



di partenza – flangia Ø 128 – **ispezioni**  
fumi/aria, completa di guarnizioni, con aerstop  
e viti

**38863**



con n. 1 manicotto  
e fascetta tubo/curva  
completa di guarnizioni

45°

#### Fascetta

In alluminio pressofuso e acciaio  
zincato

**38875**



con n. 1 manicotto EPDM e fascetta tubo/tubo  
completa di guarnizioni

### TRONCHETTO ORIZZONTALE

In alluminio estruso orizzontale/verticale  
completo di guarnizioni

**38900**



Maschio/Femmina c/**ispezione** fumi/aria

### RACCORDI verniciati bianco PER COLLEGAMENTO CURVE

**38920**



Tubo/curva Ø 100

**38925**



Curva/curva Ø 60/100

### TERMINALE

per scarico/aspirazione coassiale



**38940** in pbt

FUMISTERIA



G.T. TADDIA s.r.l.

# ACCESSORI SCARICO FUMI/ASPIRAZIONE ARIA



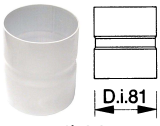
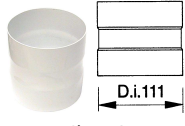

## SISTEMA COASSIALE Ø 80/110

<p><b>RACCORDO DI PARTENZA</b> PER SCARICO FUMI/ASPIRAZIONE ARIA verniciato bianco completo di guarnizioni e viti <b>38975</b></p>  <p>Compatibile per: Junkers</p>	<p><b>MANICOTTO</b> IN ALLUMINIO ESTRUSO verniciato bianco</p> <p><b>39000</b></p>  <p>Ø 80</p>	<p><b>39005</b></p>  <p>Ø 110</p>
--	--	--

## SISTEMA SDOPPIATO Ø 50 CALDAIE A CONDENSAZIONE

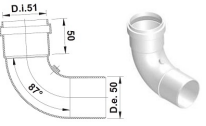
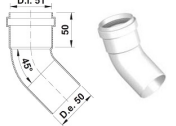
Tubi ed accessori Ø 50 molto utili in caso di sostituzione di vecchia caldaia a camera stagna con una nuova a condensazione, viene utilizzata la vecchia canna fumaria di scarico in alluminio Ø 80 facendo passare dentro il tubo flessibile in PPs Ø 50

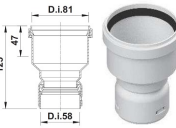
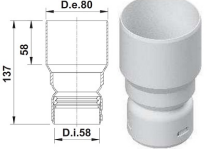
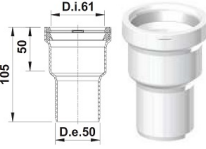
IN POLIPROPILENE (PPs) CON AUTOESTINGUENTE SP. 20/10 - complete di guarnizioni a triplo labbro in EPDM

<p><b>TUBO</b> Maschio/Femmina</p>  <table border="1"> <thead> <tr> <th></th> <th>mt</th> <th>Pz/cf</th> </tr> </thead> <tbody> <tr> <td><b>3902050</b></td> <td>0,25</td> <td>1</td> </tr> <tr> <td><b>3902150</b></td> <td>0,50</td> <td>1</td> </tr> <tr> <td><b>3902250</b></td> <td>1,00</td> <td>1</td> </tr> <tr> <td><b>3902350</b></td> <td>2,00</td> <td>1</td> </tr> </tbody> </table>		mt	Pz/cf	<b>3902050</b>	0,25	1	<b>3902150</b>	0,50	1	<b>3902250</b>	1,00	1	<b>3902350</b>	2,00	1	<p><b>CURVA</b> Maschio/Femmina</p> <p><b>87°</b> R 60 mm. - LARGO RAGGIO <b>3902650</b></p> 	<p><b>45°</b> R 50 mm. <b>3902950</b></p> 
	mt	Pz/cf															
<b>3902050</b>	0,25	1															
<b>3902150</b>	0,50	1															
<b>3902250</b>	1,00	1															
<b>3902350</b>	2,00	1															
<p><b>39050501</b> Ø50 FLEX/FLEX L=87 mm.</p> 	<p><b>RACCORDI IN PPs TRASLUCIDO</b> <b>39050502</b> Ø50 FLEX/RIGIDO M L=93 mm.</p> 	<p><b>39050503</b> Ø50 FLEX/ Ø80 RIGIDO F L=125 mm.</p> 															
<p><b>RACCORDI IN PPs TRASLUCIDO</b> <b>39050504</b> Ø50 FLEX/ Ø80 RIGIDO M L=137 mm.</p> 	<p><b>39050505</b> Ø60/50 F/M L=105 mm.</p> 	<p><b>TUBO FLESSIBILE</b> <b>3906450</b> in PPs Ø 50 - Rotolo da 20 mt. bicchieratura calibrata e completa di guarnizione a triplo labbro in EPDM grigio</p> 															

## SISTEMA SDOPPIATO Ø 60 CALDAIE A CONDENSAZIONE

IN POLIPROPILENE (PPs) CON AUTOESTINGUENTE SP. 20/10 - complete di guarnizioni a triplo labbro in EPDM

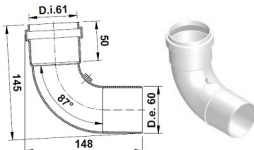
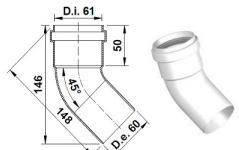
<p><b>TUBO</b> Maschio/Femmina</p>  <table border="1"> <thead> <tr> <th></th> <th>mt</th> <th>Pz/cf</th> </tr> </thead> <tbody> <tr> <td><b>3902060</b></td> <td>0,25</td> <td>2</td> </tr> <tr> <td><b>3902160</b></td> <td>0,50</td> <td>10</td> </tr> <tr> <td><b>3902260</b></td> <td>1,00</td> <td>9</td> </tr> <tr> <td><b>3902360</b></td> <td>2,00</td> <td>2</td> </tr> </tbody> </table>		mt	Pz/cf	<b>3902060</b>	0,25	2	<b>3902160</b>	0,50	10	<b>3902260</b>	1,00	9	<b>3902360</b>	2,00	2	<p><b>CURVA</b> Maschio/Femmina</p> <p><b>87°</b> R 60 mm. - LARGO RAGGIO <b>3902660</b></p> 	<p><b>45°</b> R 50 mm. <b>3902960</b></p> 
	mt	Pz/cf															
<b>3902060</b>	0,25	2															
<b>3902160</b>	0,50	10															
<b>3902260</b>	1,00	9															
<b>3902360</b>	2,00	2															

**Tubi ns art. 3902260 - 3902360 vendita solo a confezione**



FUMISTERIA



G.T. TADDIA s.r.l.

# ACCESSORI SCARICO FUMI/ASPIRAZIONE ARIA

## SISTEMA SDOPPIATO Ø 60 CALDAIE A CONDENSAZIONE

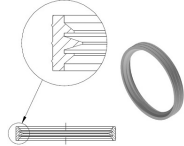
TERMINALI ACCIAIO AISI 304	
<p><b>SCARICO FUMI ORIZZONTALE</b></p>  <p><b>38255</b></p>	<p><b>ASPIRAZIONE ARIA ORIZZONTALE</b></p>  <p><b>38285</b></p>
<p><b>ROSONE COPRIMURO IN EPDM BIANCO</b></p>  <p><b>38310</b></p>	<p><b>GUARNIZIONI TRIPLIO LABBRO EPDM GRIGIO</b></p>  <p><b>38320C</b></p>

## SISTEMA SDOPPIATO Ø 80 CALDAIE A CONDENSAZIONE

IN POLIPROPILENE (PPs) CON AUTOESTINGUENTE SP. 20/10 - complete di guarnizioni a triplo labbro in EPDM



TUBO Maschio/Femmina	CURVA Maschio/Femmina																						
 <table border="1"> <thead> <tr> <th></th> <th>mt</th> <th>pz/conf.</th> </tr> </thead> <tbody> <tr> <td><b>39020</b></td> <td>0,25</td> <td>12</td> </tr> <tr> <td><b>39021</b></td> <td>0,50</td> <td>9</td> </tr> <tr> <td><b>39022</b></td> <td>1,00</td> <td>10</td> </tr> <tr> <td><b>39023</b></td> <td>2,00</td> <td>10</td> </tr> <tr> <td><b>39024</b></td> <td>2,50</td> <td>8</td> </tr> <tr> <td><b>39025</b></td> <td>3,00</td> <td>4</td> </tr> </tbody> </table>		mt	pz/conf.	<b>39020</b>	0,25	12	<b>39021</b>	0,50	9	<b>39022</b>	1,00	10	<b>39023</b>	2,00	10	<b>39024</b>	2,50	8	<b>39025</b>	3,00	4	<p><b>87°</b> R 60 mm. - LARGO RAGGIO</p> <p><b>39026</b> pz/conf. 20</p> 	<p><b>45°</b> R 60 mm.</p> <p><b>39029</b> pz/conf. 15</p> 
	mt	pz/conf.																					
<b>39020</b>	0,25	12																					
<b>39021</b>	0,50	9																					
<b>39022</b>	1,00	10																					
<b>39023</b>	2,00	10																					
<b>39024</b>	2,50	8																					
<b>39025</b>	3,00	4																					

Tubi ns art. 39023 – 39024 - 39025 vendita solo a confezione

IN POLIPROPILENE (PPs) CON AUTOESTINGUENTE SP. 20/10 - complete di guarnizioni a triplo labbro in EPDM

TEE	TAPPO	TRONCHETTO
<p>completo di guarnizione in EPDM</p> <p>con Scarico Condensa verticale - Maschio/Femmina L = 300 mm.</p> <p><b>39032</b> pz/conf. 4</p> 	<p>con tappo ispezione in PP Maschio/Maschio/Femmina L = 260 mm.</p> <p><b>39037</b> pz/conf. 6</p> 	<p>Scarico Condensa Femmina</p> <p><b>39041</b> pz/conf. 6</p> 
		<p>Raccogli Condensa Ø 80/60 Femmina/Maschio con raccordo scarico condensa maschio filettato 1/2"</p> <p>L = 134 mm.</p> <p><b>39043</b> pz/conf. 4</p> 

### RIDUZIONE

<p>Ø 60/80 Femmina/Maschio L = 100 mm.</p> <p><b>39042</b> pz/conf. 2</p> 	<p>Ø 80/60 Femmina/Maschio</p> <p>Ø 80/60 Femmina/Maschio L = 134 mm.</p> <p><b>39044</b> pz/conf. 6</p> 
---	--

### RACCORDI DI PARTENZA IN PPs

<p>e con viti fissaggio</p> <p><b>39045</b></p>  <p>Compatibile: Immergas</p>	<p><b>39046</b></p>  <p>Compatibile: Ariston – Chaffoteaux – Ecoflam – Rheem Radi</p>	<p>e con viti fissaggio</p> <p><b>39047</b></p>  <p>Compatibile: Argo – Baxi – Roca</p>	<p><b>39048</b></p>  <p>Compatibile: Beretta – Riello - Sylber</p>	<p>CON ATTACCO FLANGIA Ø 128 mm.</p> <p><b>39049</b></p>  <p>Compatibile per: Biasi – Ferroli – Fondital – Lamborghini – Nova Florida – Radiant – Savio - Sime</p>	<p><b>39050</b></p>  <p>Compatibile per: Fondital</p>
--	--	--	---	---	--

FUMISTERIA



G.T. TADDIA s.r.l.

# ACCESSORI SCARICO FUMI/ASPIRAZIONE ARIA

## SISTEMA SDOPPIATO Ø 80 CALDAIE A CONDENSAZIONE

**SDOPPIATORE MONOBLOCCO CON ATTACCHI IN PPS**  
completo di guarnizioni per flange viti di fissaggio

**39063**



Compatibile per:  
Viessmann

CON ATTACCO FLANGIA Ø 128 mm.

**39059**

attacco fumi Ø 60



Compatibile per:  
Biasi - Ferroli -- Savio

ORIZZONTALE - ACCIAIO INOX

pz/conf. 10



**38258** Ø 80

**TERMINALI SCARICO FUMI**  
VERTICALE - ACCIAIO INOX/ACCIAIO

pz/conf. 12

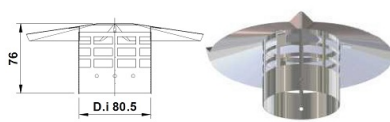

**38273** Ø 80

ORIZZONTALE ANTIGOCCIA  
- IN POLIPROPILENE NERO  
pz/conf. 10

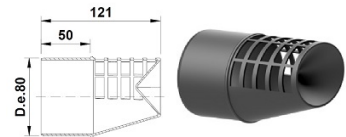

**39061**

Compatibile per: Fondital

**TERMINALI ASPIRAZIONE ARIA**

ACCIAIO INOX

pz/conf. 20



**38290** Ø 80

pz/conf. 8



**38292** Ø 80

con cappello parapiovra

**ROSONE COPRIMURO**

IN GOMMA EPDM BIANCO

pz/conf. 20



**38313** Ø 80

**COLLARE**

IN ACCIAIO  
VERNICIATO BIANCO  
Lunghezza gambo 200 mm  
pz/conf. 25



**38318** Ø 80

**GUARNIZIONI IN SILICONE A LABBRO**

SILICONE GRIGIO

pz/conf. 10

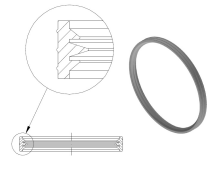

**38323C** Ø 80

**COLLARE DI CENTRAGGIO IN PPS**  
traslucido per tubo Ø 60/80/100

**39062**

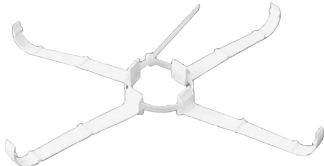

**TUBO FLESSIBILE**

in PPS Ø 80 Temperatura 120°  
Rotolo da 50 mt.  
accorciabile a moduli da L=500 mm.

**39064**



Maschio/Femmina SP 15/10

**TUBO SCARICO CONDENSA**

in PP Ø 20  
Rotolo da 50 mt.  
accorciabile a moduli da L=1 mt.

**39066**



Maschio/Femmina SP 15/10

*ad esaurimento*

**CURVA IN PPH MASCHIO/FEMMINA**  
completa di guarnizione

**87°**



**39060**

**45°**



**39075**

**TEE IN PPH**  
completo di guarnizione



**39090**

con tappo scarico condensa

FUMISTERIA



G.T. TADDIA s.r.l.



# ACCESSORI SCARICO FUMI/ASPIRAZIONE ARIA

## SISTEMA COASSIALE Ø 60/100 CALDAIE CONDENSAZIONE

completi di guarnizioni a triplo labbro in EPDM, molla di centraggio e terminale in PPs con autoestinguente, tubo esterno Ø 100 in alluminio estruso verniciato bianco

LE LUNGHEZZE INDICATE SONO DA INTENDERSI PER LA SOLA LUNGHEZZA DEL CONDOTTO COASSIALE

### KIT C 3

completo manicotto e fascetta, curva di partenza coassiale Ø 60/100 in PPs con autoestinguente/alluminio



Compatibile per:

Ariston – Beretta – Chaffoteaux et Maury – Ecoflam – Riello – Rinnai – Sylber – Vaillant – Viessman

**39080C3** MT. 1,00

### CURVA PER SISTEMA COASSIALE Ø 60 PPs/100 alluminio o PPs Maschio/Femmina

completa di guarnizione in EPDM verniciata bianca – R 60 mm.

**87°**

con ispezione aria/fumi

**45°**



**39084A** parete esterna alluminio  
**39084P** parete esterna PPs



**39086A** parete esterna alluminio  
**39086P** parete esterna PPs



**39088A** parete esterna alluminio  
**39088P** parete esterna PPs

**TUBO COASSIALE Ø 60 PPs/100 parete esterna in alluminio** verniciata bianca completa di terminale in PPs con autoestinguente e di molla di centraggio



**39095A** 750 mm.  
**39096A** 1000 mm.

### PROLUNGA COASSIALE Ø 60 PPs/100

completa di guarnizione a triplo labbro in EPDM e di molla centraggio - verniciata bianca bicchierata per sistema ad innesto – M/F



Tubo esterno in alluminio  
**39102A** 1000 mm.



**39106** 500 mm.  
**39108** 1000 mm.

### PARTENZE VERTICALI Ø 60 PPs/100 alluminio

M/F

Completo di guarnizioni per flange e viti di fissaggio

Flangia quadra 120x120

**39110**



Compatibile per:  
Immergas

Completo di guarnizione a triplo labbro in EPDM e di fascetta metallica con manicotto in EPDM

**39112**



Compatibile per:  
Ariston - Beretta Chaffoteaux - Ecoflam - Rheem Radi - Riello - Sylber Vaillant

M/F con ispezione

Completo di guarnizioni a triplo labbro in EPDM, di tappi ispezione aria/fumi, di guarnizioni per flange e viti di fissaggio

**39113**



Compatibile per:  
Argo – Baxi - Roca - Viessmann

Completo di guarnizioni a triplo labbro in EPDM, di tappi ispezione aria/fumi, di guarnizioni per flange e viti di fissaggio

Flangia Ø163

**39114**



Compatibile per:  
Hermann – Saunier Duval

M/F con ispezione

Completo di guarnizioni a triplo labbro in EPDM, di tappi ispezione aria/fumi, di guarnizioni per flange e viti di fissaggio

Flangia Ø128

**39115**



Compatibile per:  
Biasi - Ferroli -Lamborghini - Nova Florida - Radiant Savio - Sime

Completo di tappi ispezione aria/fumi, di guarnizioni per flange e viti di fissaggio

Flangia Ø128

**39116**



Compatibile per:  
Fondital

Completo di tappi ispezione aria/fumi, di guarnizioni per flange e viti di fissaggio

Flangia Ø128

**39117**



Compatibile per:  
Radiant

FUMISTERIA



G.T. TADDIA s.r.l.